



Meaningful Innovation.

WEEE Number: 80133970

# INSTRUCTION MANUAL

## LED BACKLIT PANEL

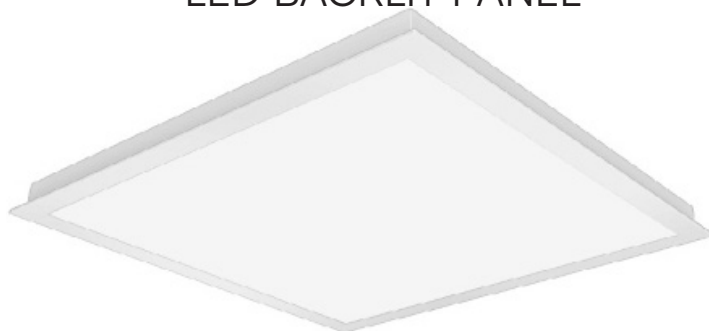

### TECHNICAL DATA

MODEL	VT-6235
SKU	23455, 23456
SHAPE	SQUARE
WATTS	36W
LUMENS	4320 Lm Useful Lumen
BEAM ANGLE	110°
CRI	>80
DF	>0.9

**05** YEAR  
WARRANTY\*

**IP65**  
RATING

Super Bright  
**120**  
LUMENS/W

LIFE SPAN	30,000 Hours
ON/OFF CYCLE	>15,000
OPERATING TEMPERATURE	-20°C to +40°C
INPUT POWER	DC: 33-40V
BODY TYPE	Aluminium+ PS
DIMENSION	595x595x34mm

### INTRODUCTION & WARRANTY

Thank you for selecting and buying V-TAC product. V-TAC will serve you the best. Please read these instructions carefully before starting the installation and keep this manual handy for future reference. If you have any other query, please contact our dealer or local vendor from whom you have purchased the product. They are trained and ready to serve you at the best. The warranty is valid for 5 years from the date of purchase. The warranty does not apply to damage caused by incorrect installation or abnormal wear and tear. The company gives no warranty against damage to any surface due to incorrect removal and installation of the product. The products are suitable for 10-12 Hours Daily operation. Usage of product for 24 Hours a day would void the warranty. This product is warranted for manufacturing defects only.

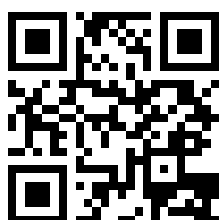

#### MULTI-LANGUAGE MANUAL QR CODE

Please scan the QR code to access the manual in multiple languages.



FR

Cet appareil, ses accessoires et cordons se recyclent

À DÉPOSER EN MAGASIN



À DÉPOSER EN DÉCHÈTERIE

OU



Points de collecte sur [www.quefairedemesdechets.fr](http://www.quefairedemesdechets.fr)  
Privilégiez la réparation ou le don de votre appareil !

In case of any query/issue with the product, please reach out to us at: [support@v-tac.eu](mailto:support@v-tac.eu)  
For More products range, inquiry please contact our distributor or nearest dealers.  
V-TAC EUROPE LTD. Bulgaria, Plovdiv 4000, bul.L.Karavelow 9B

## WARNING

1. Please make sure to turn off the power before starting the installation.
2. Installation must be performed by a qualified electrician.
3. The light source of this luminaire is not replaceable, when the light source reaches its end of life the whole luminaire should be replaced.
4. If the external flexible cable or cord of this luminaire is damaged, it shall be exclusively replaced by the manufacturer or his service agent or a similar qualified person in order to avoid a hazard.

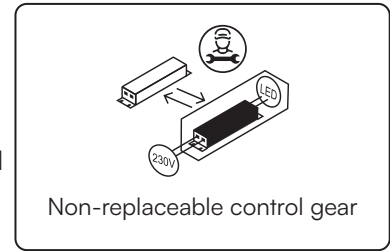

**Note:** The panel works on DC 33-40V, please connect correctly with the conductor before connecting the conductor to the power supply main.



This marking indicates that this product should not be disposed of with other household wastes.



Caution, Risk of electric shock

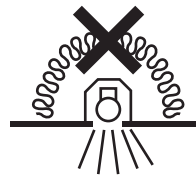

Luminaires not suitable for covering with thermally insulating material.

## INSTALLATION INSTRUCTION

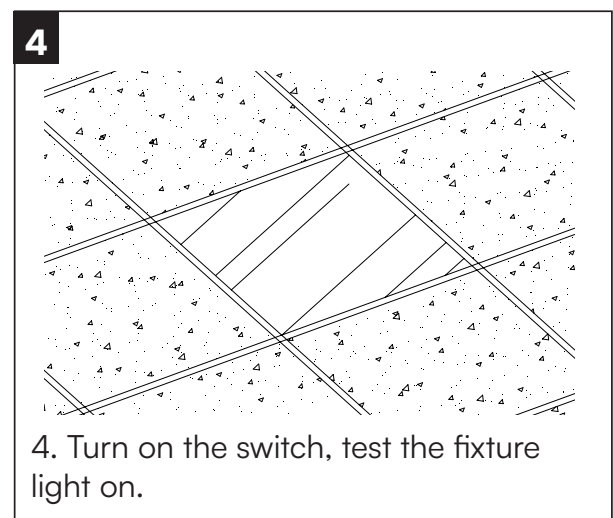
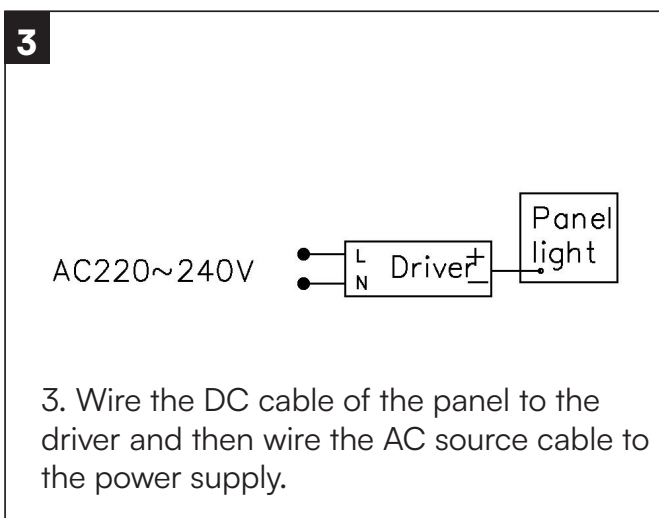
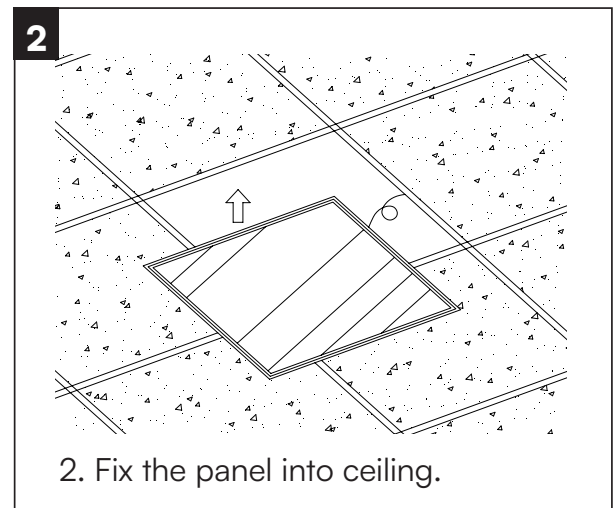
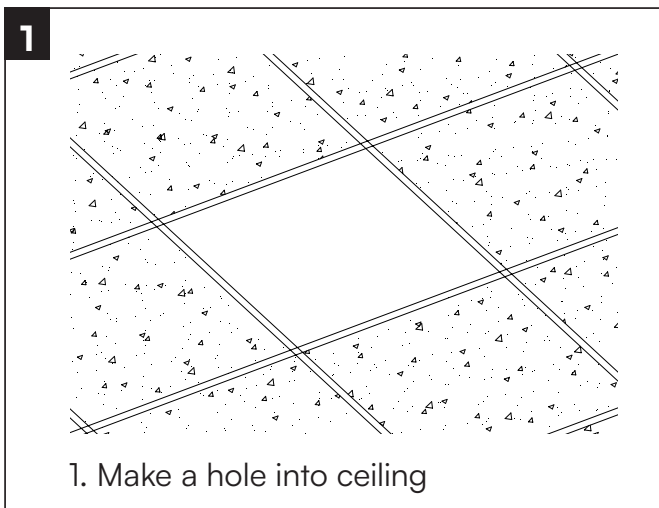

RoHS



UK  
CA



---

## DISMANTLING INSTRUCTIONS

(For Market surveillance team only)

