





# LED PROFILE PEN12 CJ 1000 ANOD.



Furniture

	<ul style="list-style-type: none"> <li>• wall and furniture application</li> <li>• obrotowość umożliwia ukierunkowanie światła</li> </ul>	<ul style="list-style-type: none"> <li> EU industrial designs</li> <li> CE</li> <li> Made in Poland</li> </ul>	 <p>Buy product</p>
---	---	---	--

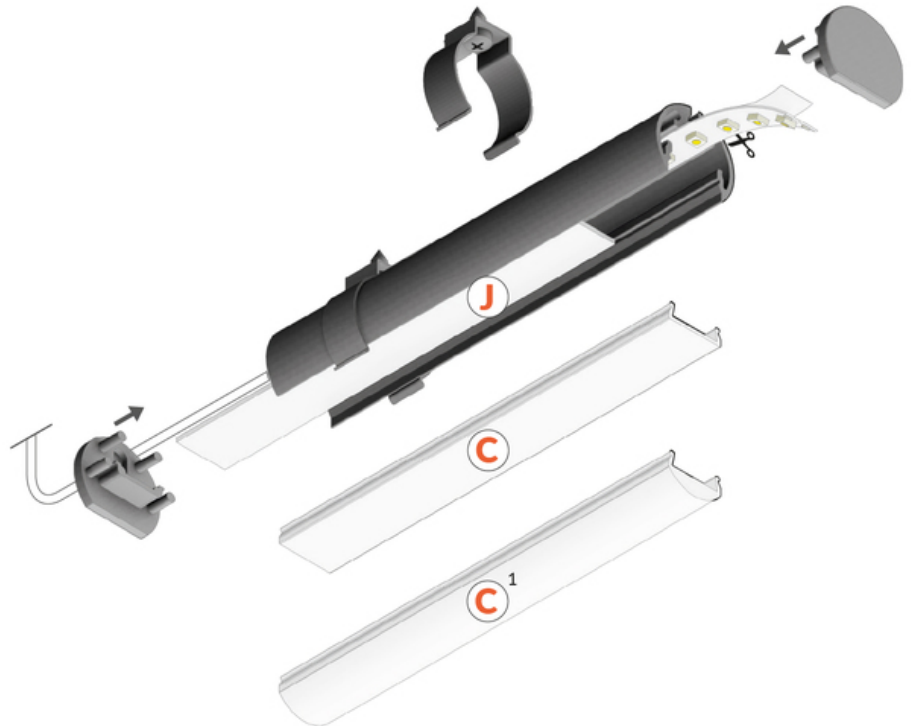
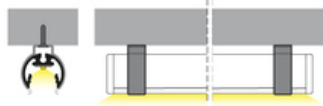
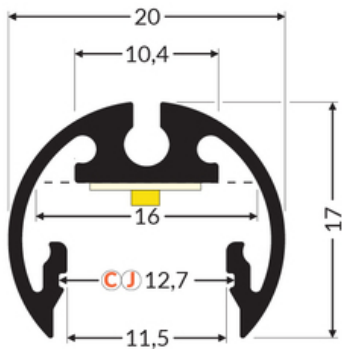



## Basic Informations

EAN: 5901597256618 Index: F7000120 Material: aluminium Color: anodized Length [mm]: 1000 Weight [kg]: 0.236 Country of origin: PL	Measurement unit: qty Product packaging dimensions [mm]: 1000 x 20 x 17 Bulk packing [qty]: 40 Master packaging type: Bulk Product with gross packaging weight [kg]: 9.44
---	---

## AVAILABLE COLORS

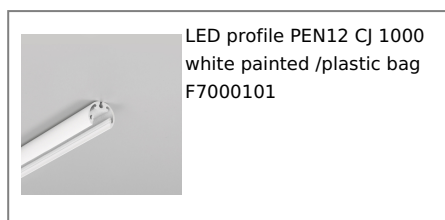

## AVAILABLE VARIANTS

1000 mm, 2000 mm, 3000 mm, 4050 mm

## Matching elements

## DIFFUSERS

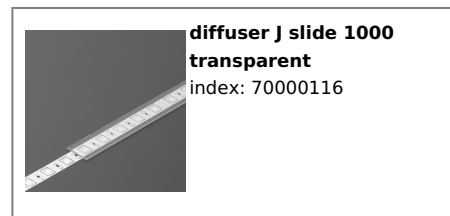
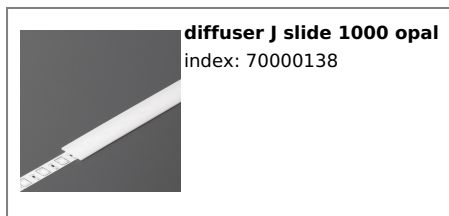
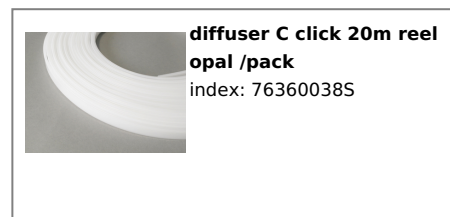
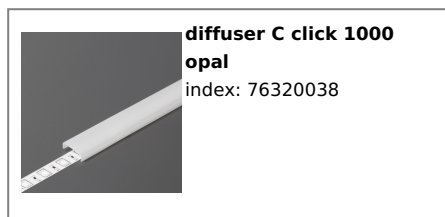
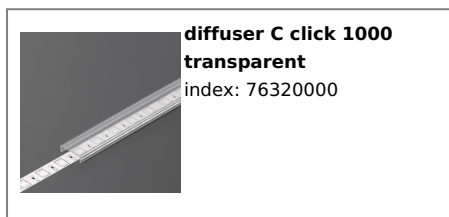

## END CAPS

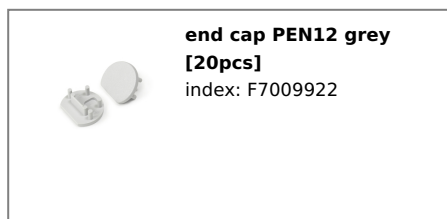
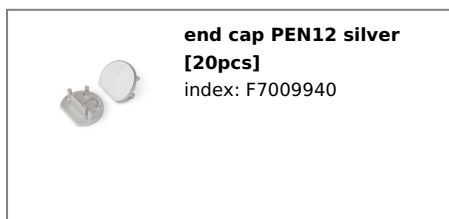

## MOUNTING PLATES

