

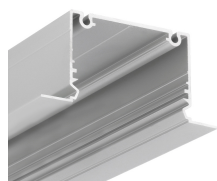



LED PROFILE PHIL RECESSED C10 1000 ANOD. /PLASTIC BAG



	<ul style="list-style-type: none">• profile for creating LED luminaires• perfect as main lighting• 3 types of covers available with different light distributions	 EU industrial designs  CE  Made in Poland	 Buy product
---	---	---	--



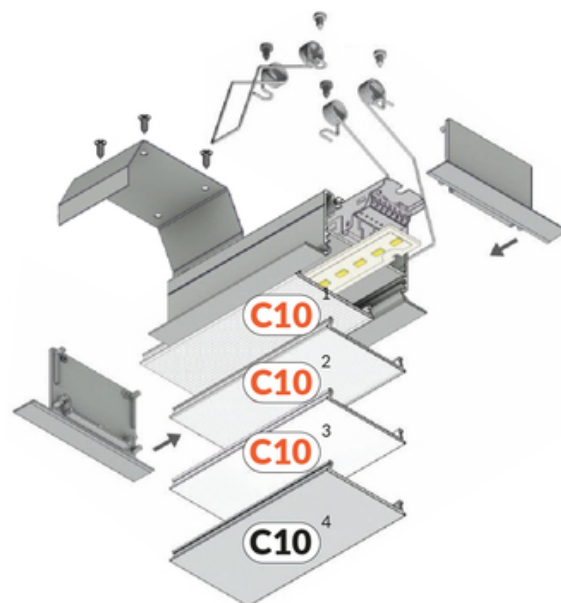
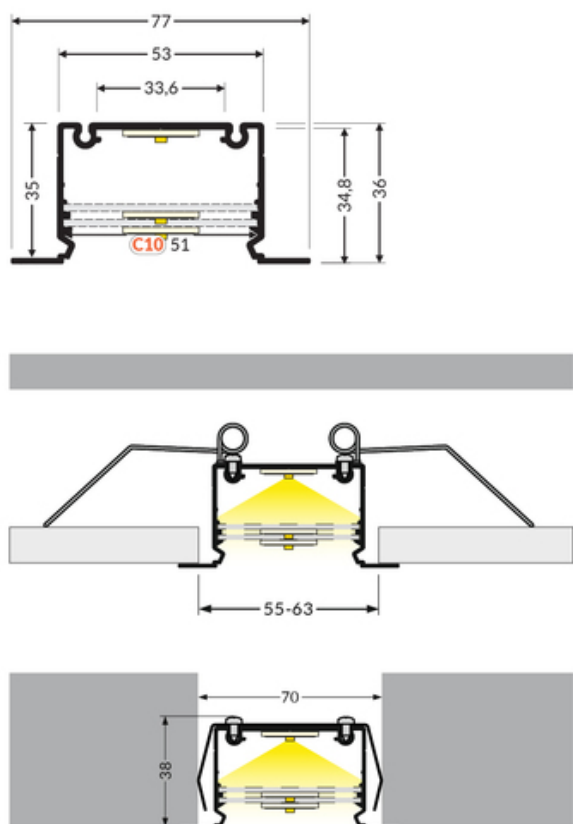

Basic Informations

<p>EAN: 5901597217480 Index: 97090020 Material: aluminium Color: anodized Length [mm]: 1000 Weight [kg]: 0.627 Net weight [kg]: 0.008000000000000001 Country of origin: PL</p>	<p>Measurement unit: qty Product packaging dimensions [mm]: 1000 x 77 x 36 Bulk packing [qty]: 8 Master packaging type: Carton Product with gross packaging weight [kg]: 5.426</p>
---	--

AVAILABLE COLORS



AVAILABLE VARIANTS

1000 mm, 2000 mm, 3000 mm, 4050 mm

Matching elements

DIFFUSERS

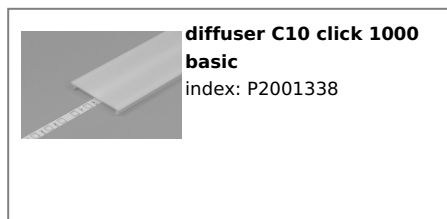
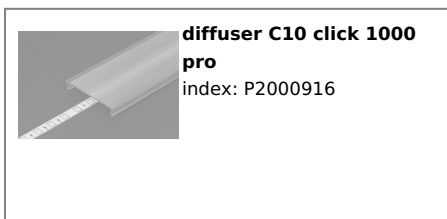

END CAPS

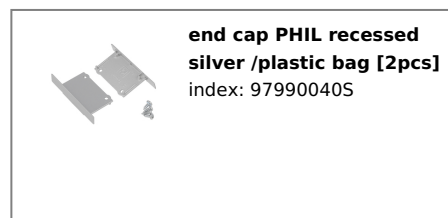

MOUNTING PLATES

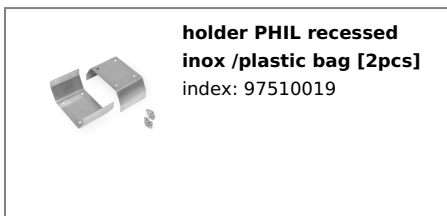

COMPLEMENTARY PROFILE

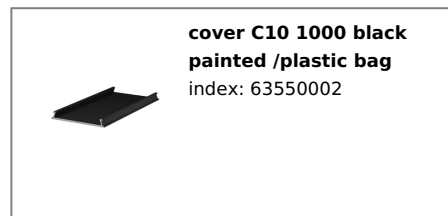
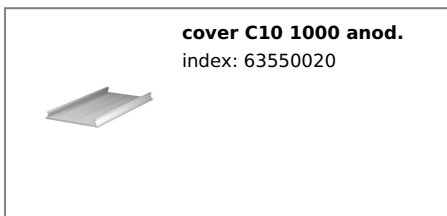

cover C10 1000 raw alu.
index: 63550000

