

# LED PROFILE UNI12 BCD/U 1000 RAW ALU.



Furniture



Surface



Recessed

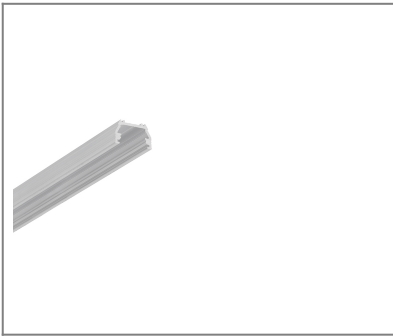

EU industrial designs



CE



Made in Poland



Buy product

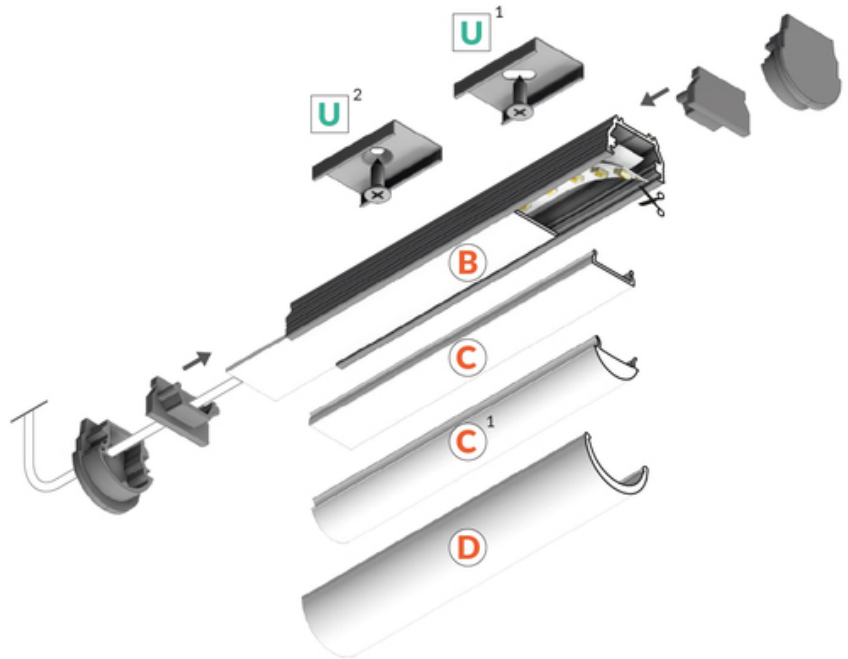
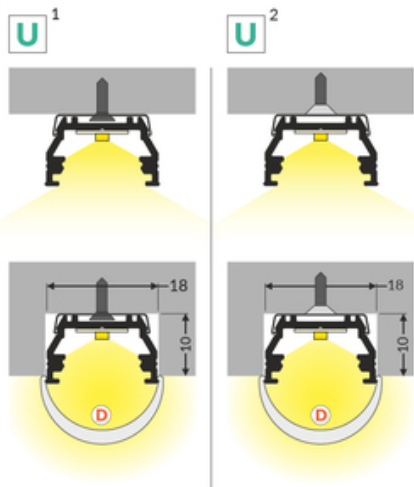
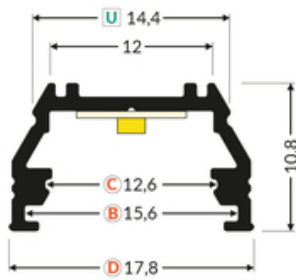

TOPMET LIGHT KŁOSOWICZ WIŚNIEWSKI sp. z o.o.

Ostrowska 354 | 61-312 Poznań | POLAND

tel.: +48 61 872 75 00

info@topmet.pl

pdf card generation date: 07.03.2025



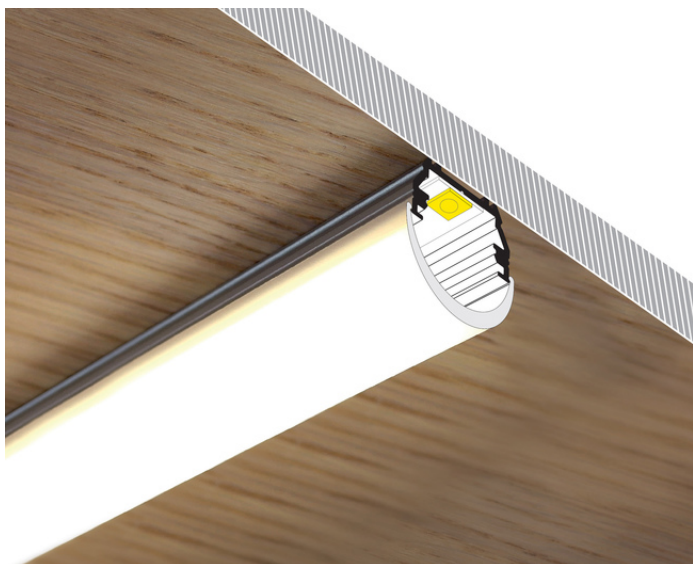

## Basic Informations

EAN: 5901597203629 Index: A1010000 Material: aluminium Color: raw aluminium Length [mm]: 1000 Weight [kg]: 0.13 Net weight [kg]: 0.012 Country of origin: PL	Measurement unit: qty Product packaging dimensions [mm]: 1000 x 17,8 x 10,8 Bulk packing [qty]: 40 Master packaging type: Bulk Product with gross packaging weight [kg]: 5.2
---	--

## AVAILABLE COLORS

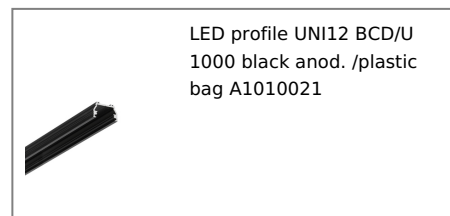
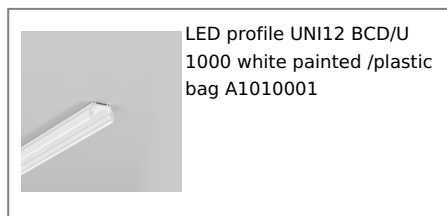
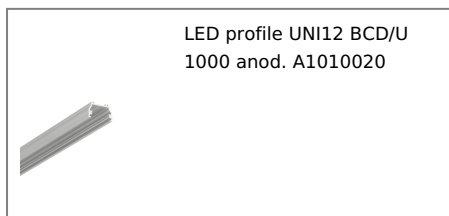

## AVAILABLE VARIANTS

1000 mm, 2000 mm, 3000 mm, 4050 mm

## Matching elements

## DIFFUSERS

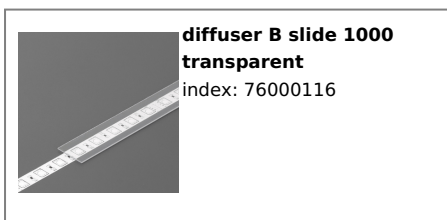
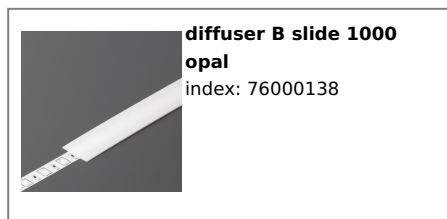
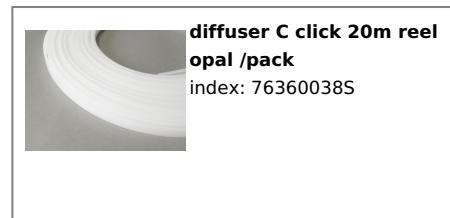
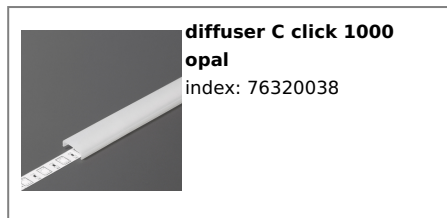

## MOUNTINGS



## END CAPS

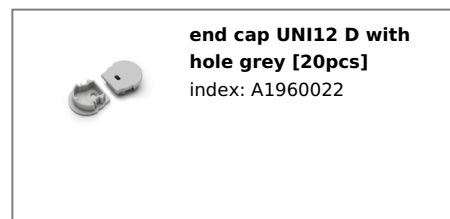
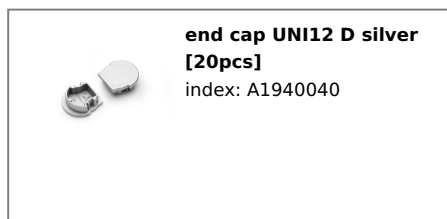
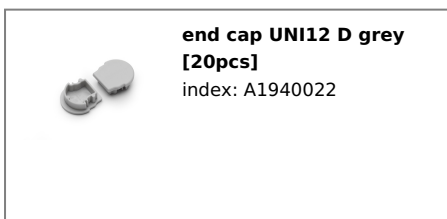



**end cap UNI12 D with  
hole silver [20pcs]**  
index: A1960040



**end cap UNI12 gen2  
grey [20pcs]**  
index: A1900022



**end cap UNI12 gen2  
silver [20pcs]**  
index: A1900040



**end cap UNI12 gen2 with  
hole grey [20pcs]**  
index: A1890022



**end cap UNI12 gen2 with  
hole silver [20pcs]**  
index: A1890040