

# LED PROFILE SURFACE14 EE7F/TY 2000 ANOD.







Furniture



max 14 mm



Surface

	<ul style="list-style-type: none"> <li>• hidden mounting</li> <li>• many system accessories available</li> </ul>	<ul style="list-style-type: none"> <li> EU industrial designs</li> <li> CE</li> <li> Made in Poland</li> </ul>	 <p>Buy product</p>
---	--	---	--

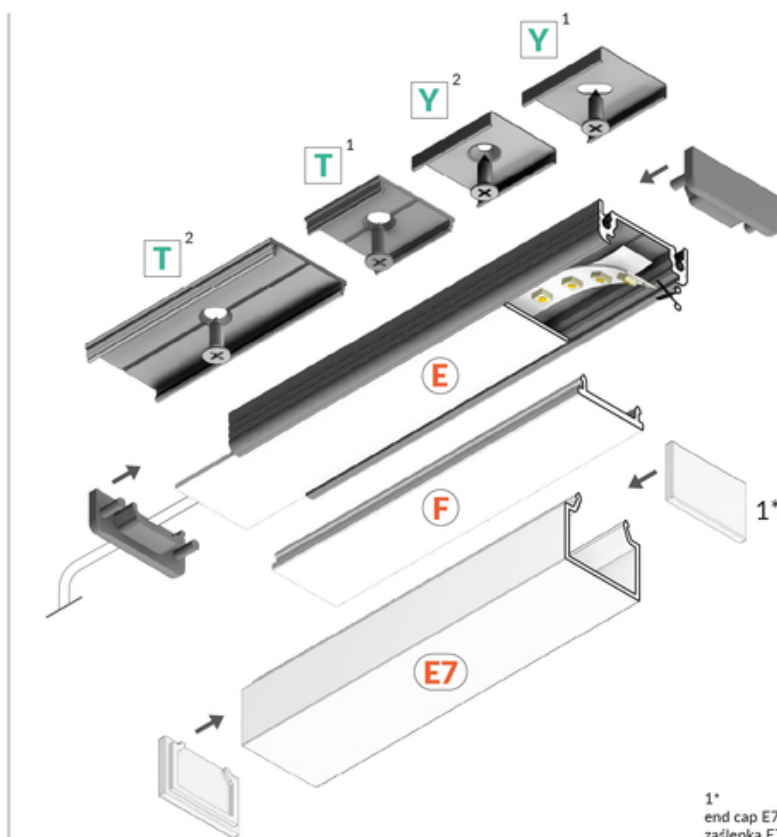
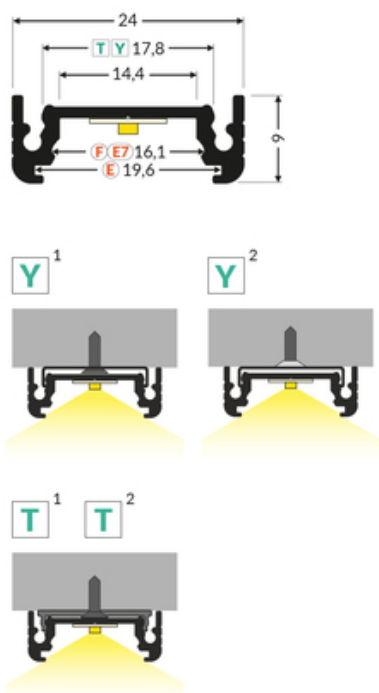

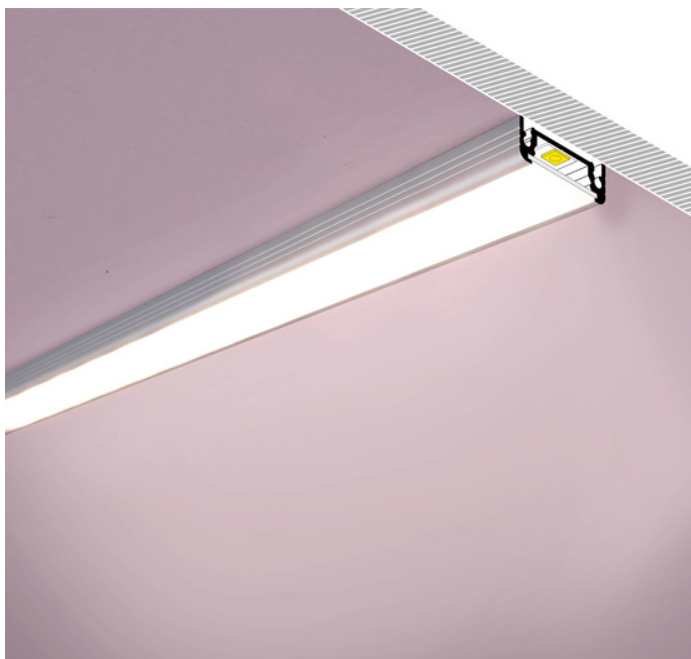

## Basic Informations

EAN: 5901597204848  
Index: A2020020  
Material: aluminium  
Color: anodized  
Length [mm]: 2000  
Weight [kg]: 0.326  
Net weight [kg]: 0.012  
Country of origin: PL

Measurement unit: qty  
Product packaging dimensions [mm]: 2000 x 24 x 9  
Bulk packing [qty]: 40  
Master packaging type: Bulk  
Product with gross packaging weight [kg]: 13.04

## AVAILABLE COLORS

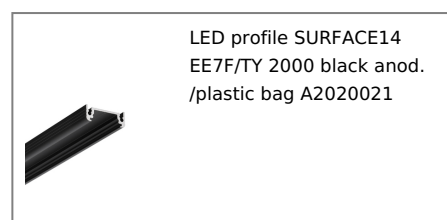
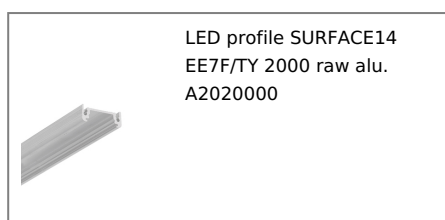
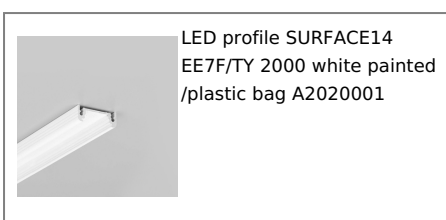

## AVAILABLE VARIANTS

1000 mm, 2000 mm, 3000 mm, 4050 mm

## Matching elements

**TOPMET LIGHT KŁOSOWICZ WIŚNIEWSKI sp. z o.o.**  
Ostrowska 354 | 61-312 Poznań | POLAND  
tel.: +48 61 872 75 00  
info@topmet.pl

pdf card generation date: 10.03.2025

## DIFFUSERS



## MOUNTINGS

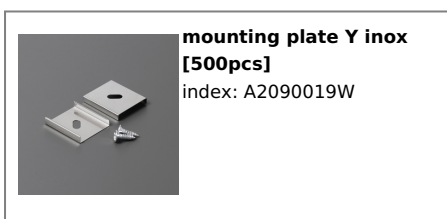

## END CAPS

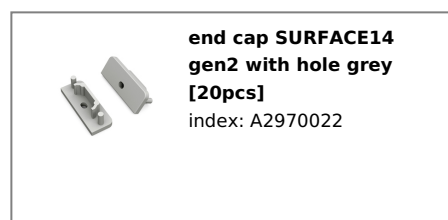
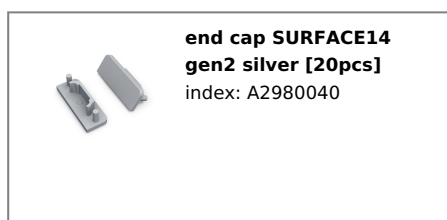

TOPMET LIGHT KŁOSOWICZ WIŚNIEWSKI sp. z o.o.

Ostrowska 354 | 61-312 Poznań | POLAND

tel.: +48 61 872 75 00

info@topmet.pl

pdf card generation date: 10.03.2025



**end cap SURFACE14  
gen2 with hole silver**  
[20pcs]  
index: A2970040

---

## CONNECTORS



**connector SURFACE14  
90deg anod. /plastic bag**  
index: A2990020



**connector T 180deg  
/plastic bag**  
index: C6990000



**connector T 180deg  
/plastic bag [200pcs]**  
index: C6990000W